

Northeastern University

PARSEC: Percussive And Rotary Surveying & Extracting Carousel

NASA RASC-AL Moon to Mars Ice & Prospecting Challenge
2020-21 Final Technical Paper



Team Lead: Samuel Hibbard (ME, 2nd Year)

Mechanical Lead: Ethan Holand (ME, 2nd Year)

Systems Lead and Treasurer: Jarrod Homer (EE, 2nd Year)

Software and Electrical Lead: Ian Burwell (CE, 2nd Year)

Digital Core Lead: John Wilkins (CS & Physics, 2nd Year)

Team members: Alex Storrer (ME & Physics, 2nd Year), Isabella Morizio (ME, 1st Year), Neha Bhattachan (ME, 1st Year), Maria Fountas (ME, 2nd Year), Kyle Ednie (CS & Physics, 2nd Year), Harrison Kim (CE & CS, 1st Year), Dina Zemlyanker (DS & Biochem, 2nd Year), Konrad Sroka (ME, 1st Year), Vedant Rautela (CS & Physics, 2nd year), John Alessio (CE & CS, 2nd Year)

Advisors: Professor Taskin Padir, Mark Zolotas

Table of Contents

1	Executive Summary	3
1.0	Introduction	3
1.1	Frame and Movement	3
1.2	Drilling Operations	3
1.3	Digital Core Prospecting	3
1.4	Melting and Extraction	3
1.5	Filtration	3
1.6	Core Sampling	3
1.7	Hardware Control	3
2	System Description	4
2.1	Structural Framing & Carousel	4
2.2	Martian Overburden Layer Excavator (MOLE)	4
2.3	Melting and Extracting Liquid Tool (MELT)	5
2.4	Potable Liquid Extraction & Cleaning Osmosis System (PLECOS)	6
2.5	Core Analysis Tool (CAT)	6
2.6	Controls and Communication	7
2.7	Methodology utilized for prospecting for a digital core	8
3	Overall Competition Strategy	10
4	Design Changes/Improvements	11
5	Technical Specifications	11
6	Challenges	12
7	Integration & Test Plan	12
8	Project Timeline	13
9	Tactical Plan for Contingencies	13
10	Safety Plan	13
11	Paths-to-flight	14
11.1	Mars Operation	17
11.2	Lunar Operation	18
12	Budget	18
	References	19

Nomenclature

<i>PARSEC</i>	Percussive And Rotary Surveying & Extracting Carousel
<i>MOLE</i>	Martian Overburden Layer Excavator
<i>WOB</i>	Weight On Bit
<i>MELT</i>	Melting & Extracting Liquid Tool
<i>CAT</i>	Core Analysis Tool
<i>PLECOS</i>	Potable Liquid Extraction & Cleaning Osmosis System
<i>RO</i>	Reverse Osmosis
<i>ROS</i>	Robot Operating System
<i>BITE</i>	Background Interim Terrain Estimator
<i>CHEW</i>	Consequent High-volume Experiential World-guesser
<i>SPIT</i>	Standardized Probability-to-Inference Transformer
<i>RTG</i>	Radioisotope Thermoelectric Generator
<i>ICA</i>	Independent Component Analysis (ICA)
<i>MFCC</i>	Mel Frequency Cepstrum Coefficient
<i>ANN</i>	Artificial Neural Network
<i>RNN</i>	Recurrent Neural Networks
<i>HMM</i>	Hidden Markov Models
<i>SWA</i>	Stochastic Weight Averaging
<i>LSTM</i>	Long Short-term Memory node
<i>LpModel</i>	Linear Programming based model

3D Model

To view PARSEC's 3D model, click or scan the QR code below.

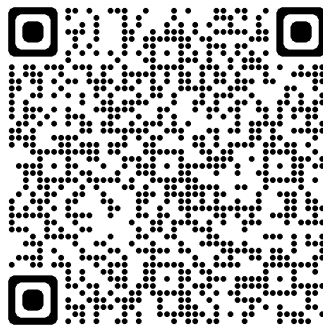

1 Executive Summary

1.0 Introduction

The Northeastern University Percussive And Rotary Surveying & Extracting Carousel (PARSEC) has been developed to overcome one of the largest obstacles in Martian and lunar colonization: in-situ water extraction. PARSEC can expose, melt, extract, and filter subsurface ice, while providing geological insight. The system was developed within the design objectives and constraints set by NASA's 2020-21 RASC-AL Moon to Mars Ice and Prospecting Challenge.

1.1 Frame and Movement

PARSEC's three tools, filtration system, and electronics are mounted to a 360° rotary carousel, increasing hole reach and enabling simultaneous tool operation. The carousel is mounted on an aluminum frame which is secured to the testbed with four brackets.

1.2 Drilling Operations

PARSEC uses a rotary-percussive drill with a masonry auger to bore through layers of regolith and ice. A tachometer, load cell, current sensor, and two microphones provide data for evaluating digital core layers. Upper and lower stabilizers mitigate vibrations and prevent the bit from walking. The drilling system creates a hole used by the melting system to access the ice.

1.3 Digital Core Prospecting

Three separate algorithms are used to generate the digital core; BITE, which classifies regolith in real-time during drilling using a Hidden Markov Model; CHEW, which classifies regolith after drilling using various machine learning models including neural nets, recurrent nets, gradient boost and logistic regression; and SPIT, which aggregates and ranks the layers by hardness.

1.4 Melting and Extraction

The melting and water extraction tool uses a compliant articulating and rotating melting tool to stay in continuous contact with the ice. Heating is provided by cartridge heaters and monitored by a pair of thermocouples. A stationary tube extracts water as it is melted.

1.5 Filtration

PARSEC uses a two stage filtration process to produce drinkable water. The first stage, a purgeable sedimentary filter, removes larger particulates from the water. The second stage, a reverse osmosis membrane, removes particles as small as 0.1 nm.

1.6 Core Sampling

The core sampling tool is designed to collect samples and images of subsurface layers for the purpose of scientific study. This is done using an articulating rotary file and a revolving sample holder.

1.7 Hardware Control

At PARSEC's center is a NVIDIA Jetson Nano computer, allowing PARSEC to run complex algorithms and perform other high-level operations such as video encoding and hardware control. The Jetson runs the Robot Operating System (ROS) and communicates with multiple distributed microcontrollers, allowing hardware control over the extended ethernet network via a simple GUI.

2 System Description

2.1 Structural Framing & Carousel

PARSEC's outer frame is composed of 1.5" 80/20 aluminum extrusions. It mounts to the testbed with wood screws inserted into four adjustable L-brackets. At the center of the frame lies the rotary tool carousel, seen in Fig. 1, which contains all tools necessary for potable water extraction,

PARSEC's rotary carousel enables tool swapping and simultaneous tool operation. It maximizes potential drilling area for a 1 degree of freedom mechanism in a given volume. The carousel's upper and lower turntables spin with minimal friction. Machined aluminum plates secure the turntables' inner and outer rings to the carousel and frame respectively. These plates were machined with internal pockets to reduce weight by 34% while maintaining rigidity.

The carousel is driven at its base by a single DC motor equipped with a 100:1 2-stage planetary gearbox capable of rotating the carousel at 66 RPM with 6.2 N·m of torque. A quadrature encoder integrated into the motor determines the carousel's position. This positional feedback allows the motor to run in a closed-loop control scheme and precisely position itself during tool swaps and moves.

Two linear actuators lock the carousel's angle of rotation before a drilling operation. They interface with 24 holes drilled in a uniform radial pattern, allowing the carousel to brake in 15° increments. One of the actuators is equipped with a conical head capable of self-alignment. With this first actuator in place, the second actuator can insert into one of the interfacing holes and lock the system in place.

Four linear rods, two leadscrews, and a ball screw mounted to the carousel enable vertical motion for each tool and double as structural members that join the upper and lower turntables. The ball and lead screws are seated in bearings and driven by steppers via belts. All axes, including carousel rotation, feature limit switches to allow for each tool to home at system startup.

PARSEC's three tools are positioned 90° apart. The fourth position features a 1" 80/20 post on which the electronics and filtration system are mounted. To reduce rotational unbalance, each tool is positioned to oppose one of similar weight, keeping the center of mass close to the center of rotation.

2.2 Martian Overburden Layer Excavator (MOLE)

PARSEC operates a Makita HR4002 SDS-MAX rotary-hammer drill to simultaneously pulverize hard layers and bore through tough layers. It uses a TE-YX Hilti masonry auger with a 1-9/16" diameter and a 775 mm working length. A ball screw provides low-friction vertical actuation of the drill.

Two hollow aluminum linear rails guide the drill and provide stability. Vibrations caused by drill percussion are mitigated by a cross-brace secured to these rails with rubber dampeners. This brace additionally serves as the mounting point for a homing switch.

A 3D-printed upper stabilizer grips the handle of the drill as shown in Fig. 2. With the stabilizer, the pitch of the auger can be tuned using an embedded screw and adjustable hose clamp. To prevent the auger from walking, it is laterally constrained by a bearing mounted to the lower base plate.

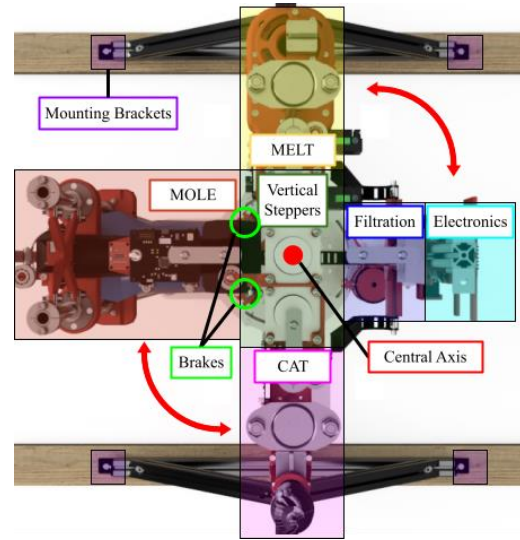

Fig. 1. Carousel, Top View

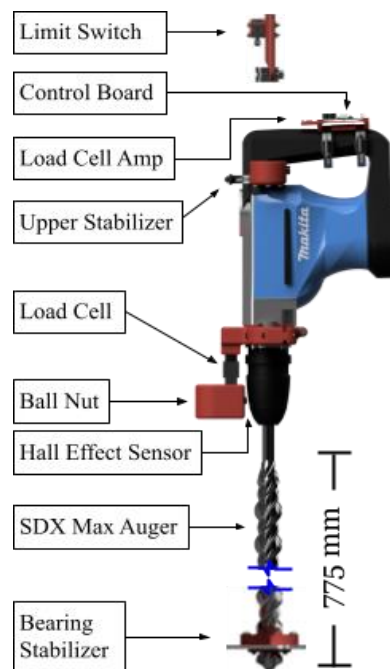

Fig. 2. MOLE

The entire load path of the drill is directed through an s-type load cell coupled to the ball nut, providing weight on bit (WOB) data. Mounted nearby, a hall effect sensor reads a revolving magnet on the drill's chuck, acting as a tachometer to measure RPM. Additionally, a current sensor tracks drill power consumption, and microphones detect vibrations. The sensor data is read by a local microcontroller that is attached to the drill and communicates back to PARSEC via a single USB cable. The power cord for the drill is controlled by a relay.

To avoid bit freezing, the real-time data processing algorithm, BITE, will determine when ice has been reached and prompt the system to retract once 10 cm of ice is drilled. The drill's 14.75 N·m of torque and frictional drilling heat has been sufficient to prevent freezing in ice during testing.

2.3 Melting and Extracting Liquid Tool (MELT)

PARSEC melts ice and extracts liquid water using a heating probe that descends into previously drilled holes. The probe is designed to maximize conduction by articulating and rotating to maintain contact with the ice.

The MELT probe mounts to the end of a 1 m carbon fiber tube. It rotates inside a pillow block attached to a lead screw and linear rail by a pair of load cells, shown in Fig. 3. The rotation is driven by a stepper motor via a belt and pulley attached to this upper assembly. The articulation is controlled by another stepper motor at the top of the tube with an aluminum shaft running down to the probe.

Just above the probe, the shaft rotates a micro lead screw which vertically drives a rotationally constrained wire rope end fitting. This wire rope restrains the melting arm, which is constantly torqued outward around a pivot by a pair of torsion springs. The angle of the melting arm is tracked by a linear potentiometer following a cam built into one of the hinge plates. This combination allows for both compliant control and precise articulation feedback.

The melting arm consists of two machined aluminum shells, which are clamped together with liquid silicone gasket material for a waterproof assembly. The shells feature slots for swappable heaters, springs, thermocouples, and hinge joint plates. The probe and tube fit flush inside a 38 mm diameter hole.

MELT contains two ¼" x 6" 400 W cartridge heaters that are toggled using individual relays. The heaters have a custom

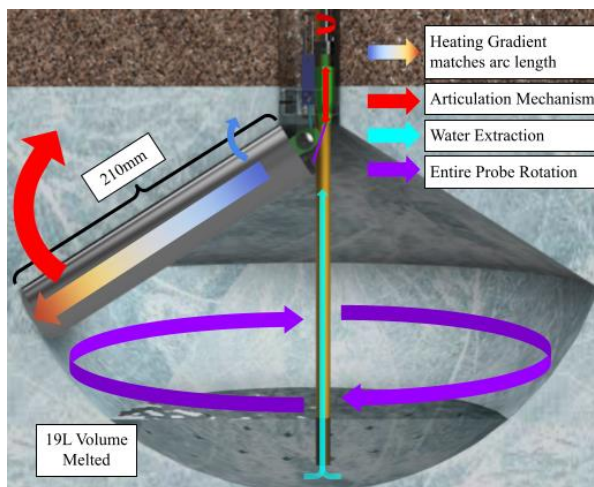

Fig. 5. MELT Bowl Creation

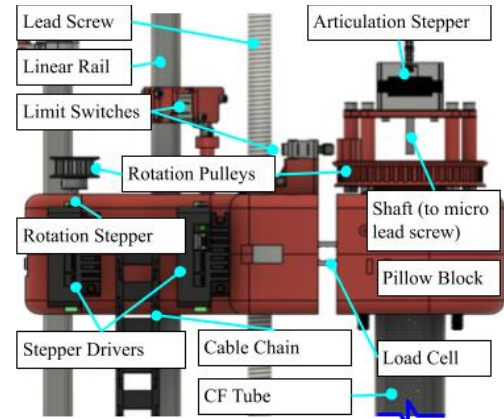

Fig. 3. MELT Upper Assembly

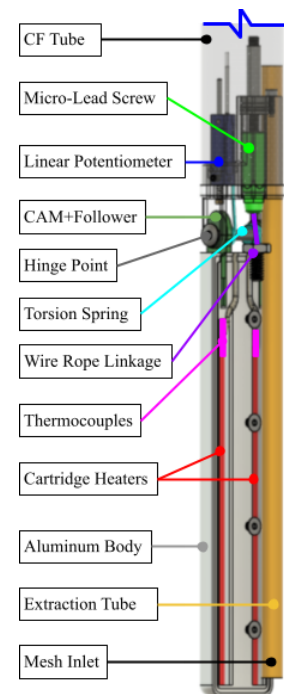

Fig. 4. MELT Probe

profiling watt density, which concentrates heat to the bottom of the probe, improving downwards melting efficiency. The local heat also corresponds to the arc length that each point travels while articulating. The probe's temperature is monitored by a pair of thermocouples nested in the heaters.

Utilizing both rotation and articulation, the probe is capable of melting out a hemispherical sector with a radius equal to the 210 mm melting arm length. The probe rotation, articulation and temperature are controlled by a custom microcontroller mounted on the upper assembly. A stationary aluminum tube nested into the melting arm extracts water through a mesh inlet before it is pumped to the filtration system.

2.4 Potable Liquid Extraction & Cleaning Osmosis System (PLECOS)

PLECOS, seen in Fig. 6, uses a two-stage filtration process, seen in Fig. 7, to produce drinkable water. It can remove contaminants as small as 0.1 nm while consuming minimal power.

A peristaltic pump drives water from MELT into a custom spin-down filter shown in Fig. 8. This first-stage sedimentary filter removes the undissolved contaminants using a 1 μm mesh nested inside a 75 μm mesh. Water exits a central tube to the reverse osmosis (RO) basin. A diaphragm pump feeds water pressurized at 85 psi through an RO membrane. An 800 cc flow restrictor ensures proper permeate yield. Clean water is then collected from the membrane while brine is recirculated. A 3-way valve allows brine to be outputted for industrial applications where potable water is not needed.

Built-up sediment in the first stage can be purged by opening a return valve and pumping it back into the drilled hole. In the event of a clog, the peristaltic pump can run in reverse and backwash the inlet.

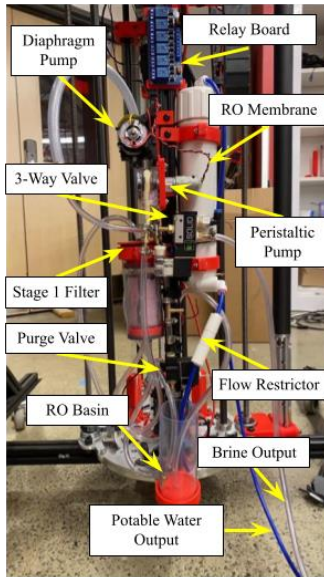

Fig. 6. PLECOS

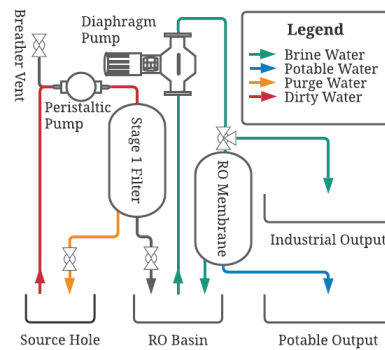

Fig. 7. Flow Diagram

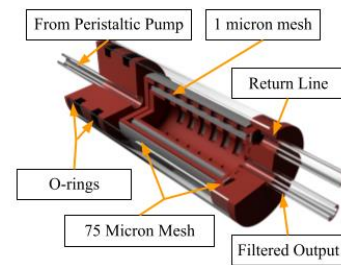

Fig. 8. First Stage Filter

2.5 Core Analysis Tool (CAT)

The Core Analysis Tool takes advantage of the unique opportunity to access exposed Martian and Lunar subsurface layers to collect physical samples for research purposes beyond digital core synthesis. CAT is mounted to a lead screw and linear rail on the carousel 180° offset from MELT, allowing it to collect samples while MELT is being used in a different hole.

The upper section of CAT contains a Dremel 100-N/7 Rotary Tool to drive a flex shaft while a stepper motor controls the cutting bit's articulation. This motor is coupled to a shaft running down a 600 mm carbon fiber tube, where it leads to the articulation mechanism. The shaft drives an eye bolt micro-lead screw, which causes a slot linkage to rotate. This slot linkage is coupled to the end of the flex shaft, allowing the rotary file to articulate. When articulated, this file carves away layers of regolith that are directed by a funnel into a sample holder for retrieval. The sample holder is then rotated by a stepper motor to align four different collection

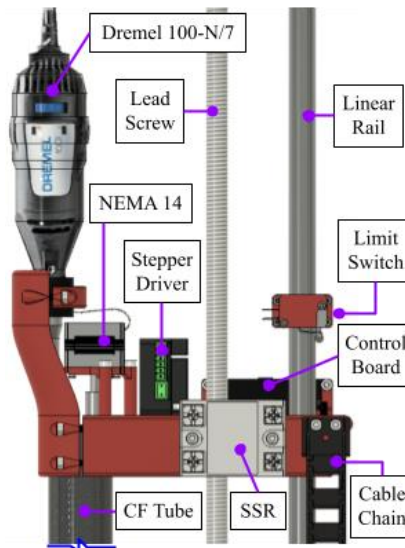

Fig. 9. CAT Upper Assembly

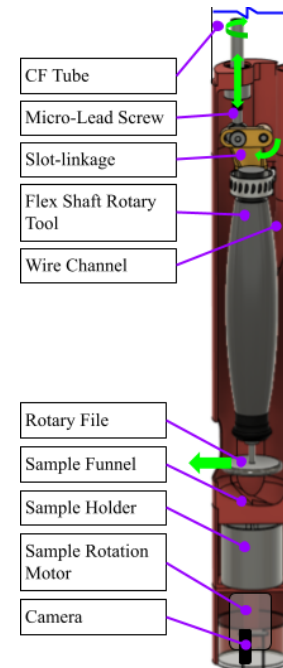

Fig. 10. CAT Sample Collection Mechanism

chambers with the funnel. CAT also contains a downward-facing endoscopic camera capable of examining layers and melting patterns up close.

2.6 Controls and Communication

PARSEC is controlled locally by a distributed computing system centered around an NVIDIA Jetson Nano computer capable of running both control automation and complex digital core data models. Within the scope of control, the Jetson acts to process all incoming and outgoing data from the remote ground station and to translate and send commands to PARSEC's distributed microcontrollers. This communication is achieved by leveraging the networking strength of the Robot Operating System (ROS).

With a ROS server running on the Jetson, a ground station can reliably connect to the ROS network with an ethernet cable. On the network, the ground station has access to all ROS topics ranging from PARSEC's control state to raw sensor data. A secondary data logger can thus run on the ground station and gather info such as WOB, drill RPM, and current consumption in case of system failure. With initial hardware abstraction handled by the Jetson, the ground station performs final system abstraction by providing a graphical interface to the operator (as seen in Fig. 12).

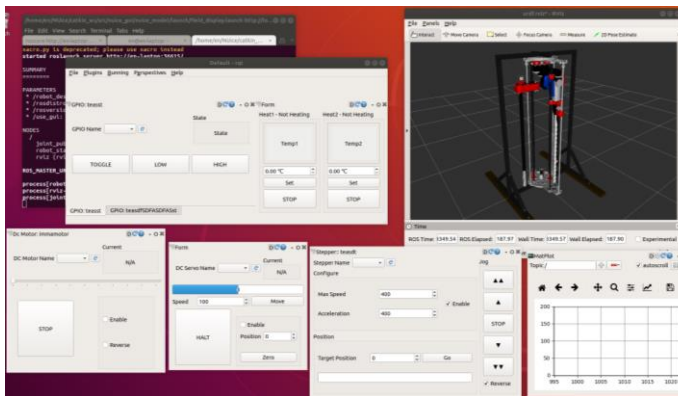

Fig. 12. User Interface

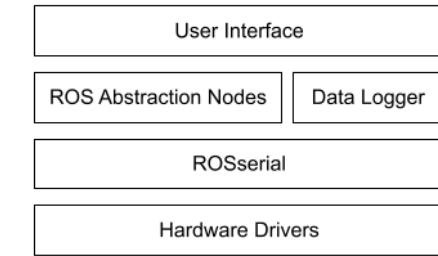

Fig. 11. Software Stack

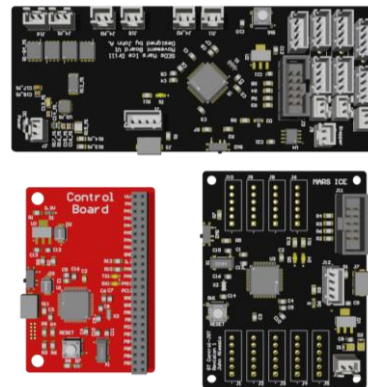

Fig. 13. Custom Control Boards

To alleviate excessive computing from the Jetson, multiple custom microcontrollers (see Fig. 13) handle the lowest-level hardware integration. To interface with the Jetson, each of these processors implements a serial communication protocol over USB called ROSserial. This protocol, along with the twisted-pair wiring of USB, provides a reliable data connection between the Jetson and each distributed controller.

With a reliable connection to the Jetson, the microcontrollers can perform time-critical interfacing with their respective motor controllers and sensors. A top-level breakdown of the electrical system of PARSEC can be seen in Fig. 14.

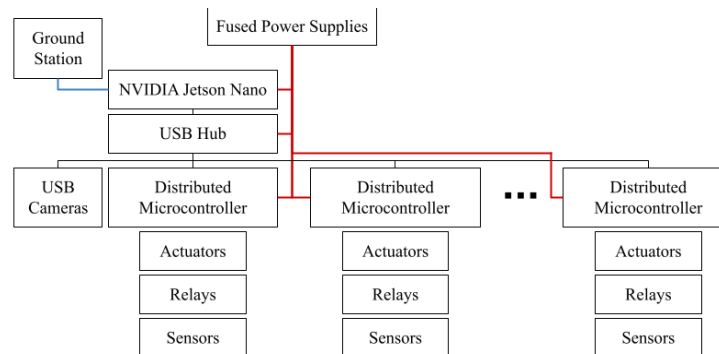

Fig. 14. Control Systems Hierarchy

2.7 Methodology utilized for generating a digital core

PARSEC implements a variety of classification machine learning algorithms to identify the layer materials, estimate their positions and rank them by hardness. This is accomplished using three algorithms: BITE, CHEW, and SPIT.

These algorithms use WOB, current, drill rotational speed, position, and audio as inputs. Data is processed to get rid of null values, extract velocity, remove repeated positions, and drop unneeded features.

The audio data has its own feature extraction step using a combination of Independent Component Analysis (ICA) to remove noise caused by the drill and Mel Frequency Cepstrum Coefficients (MFCC), a representation of the short-term power spectrum of a sound. Positive values correspond to majority high frequencies in the audio frame and negative values correspond to majority low. Twenty coefficients are extracted for each frame creating an imbalance in the number of audio and non-audio features. Two methods, Hive and Principal Component Analysis (PCA), help to address this through pre-processing steps to prevent the overweighting of the audio modality.

The goal of PCA is to explain a maximal amount of variance in the least amount of features. Principal components are constructed as linear mixtures of the initial features by calculating eigenvectors and eigenvalues from covariance matrices between the initial features. This creates a new set of uncorrelated features meaning that the majority of the information is contained in the first few features of this new set.

Hive, as seen in Fig. 16 uses a custom architecture containing two sister Recurrent Neural Networks (RNN) that perform dimensionality reduction. The first network takes in non-audio features, while the second can accept either engineered audio features or the raw audio file as input. The outputs of the RNNs have equal length, eliminating the overweighting of the audio modality. The two feature vectors are then concatenated and fed into an Artificial Neural Network (ANN).

BITE assists PARSEC and its operators by providing live predictions of the material being drilled through using a Hidden Markov Models (HMM). It fits into PARSEC's ROS network as a node, subscribing to incoming sensor information and publishing a prediction of the current layer every second. This assists operation of PARSEC by providing guidance of when ice has been reached, signaling when a switch from drilling to melting is appropriate.

After drilling, CHEW creates more accurate predictions of the subsurface layers by using audio data, and depth consideration from the entire drilling operation's data log, using an array of models using ensemble learning. Ensemble learning is the process of combining predictions from multiple models to get the best result. All of this makes CHEW best suited for the regolith prediction used to generate a core analysis with SPIT.

The five basic machine learning models used are Artificial Neural Networks (ANN), Recurrent Neural Networks (RNN), Logistic Regression, Gradient Boosting, and Hidden Markov Model (HMM). The Logistic Regression and Gradient Boost models were chosen because of their relative speed and their

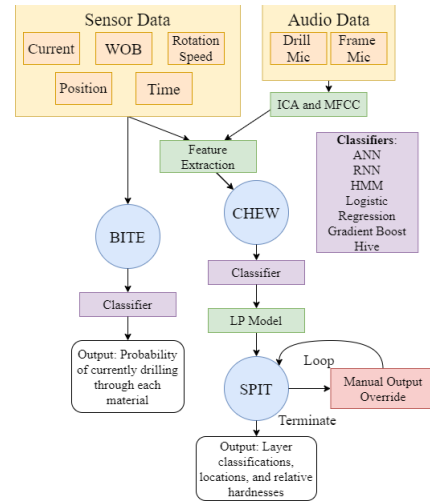

Fig. 15. Digital Core Flow and Hierarchy

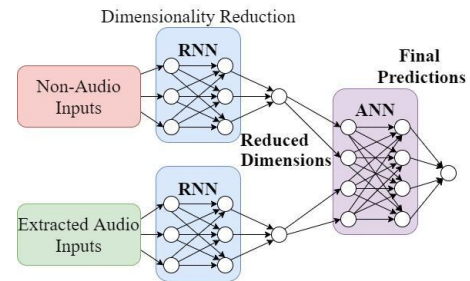

Fig. 16. Hive Architecture

complementary optimization for large and small datasets respectively. However, Logistic Regression has the drawback of only being able to create linear decision boundaries. Gradient Boosting doesn't assume anything about the data, but requires large amounts of data for high performance. The HMM and RNN models were chosen because of their ability for sequential processing. This means that the prediction for the previous layer is used as an additional feature to determine the identity of the current state which is useful since rapid layer switching is not expected. The HMM achieves this with a transition matrix that is trained with Expectation Maximization by attempting to converge to parameters with maximal likelihoods. During each time step, the HMM calculates the probability of belonging to a specific state, given the probability of belonging to a certain state based on sensor data and the probability of transitioning from the previous state to the proposed one. In RNNs, an extension of ANNs, sequential processing is achieved through Long Short-term Memory (LSTM) nodes, which periodically store an input to memory and use it to inform the decisions for the current prediction.

SPIT is a conversational output system that receives initial predictions from CHEW and responds to human overrides with updated predictions. It is tasked with both aggregating the classified regolith into layers ranked by hardness, and providing visualizations of data to support human interfacing. SPIT ranks layers' hardnesses using pseudo-average energy density. This was chosen under the principle that objects that are harder have more chemical energy binding them together and therefore require more energy to break apart.

$$\text{pseudo hardness} = \sum_t \frac{VI_t \Delta t}{A \Delta x}$$

V = voltage, I_t = discrete current, A = cross sectional area, t = time, x = position

To enhance the performance of CHEW's prediction capabilities, a Linear Programming based model was created (LpModel). The LpModel takes the output of another prediction model in the form of a probability matrix as its input. It then maximizes a Linear Programming problem with the following objective function that encourages agreeing with the original classifier while discouraging switching between layers. The LpModel hyperparameters are set to completely agree with the original model until an optimal selection is found to increase each individual model's accuracy.

$$\sum_j \sum_i^{state \ vector} M_{ij} X_{ij} + \sum_i \sum_j^{direction \ state} W_{ij} \sigma_{ik}$$

M = input matrix, X = output matrix, W_i = vector penalty weights associated with direction i , σ = column wise summation of X associated with direction i ,
 $direction = [into, out of]$

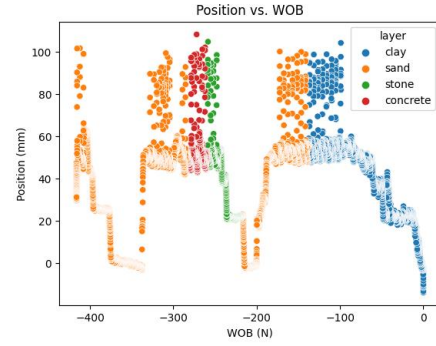

Fig. 17. Position vs WOB Data

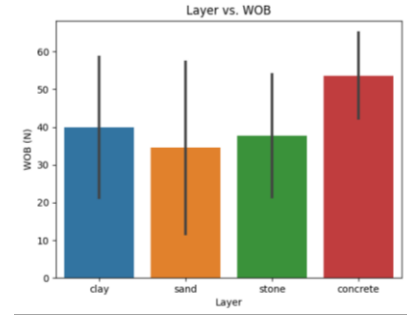

Fig. 18. Layer vs WOB data

The weights of the penalties for switching between layers (W) are trained using Stochastic Weight Averaging (SWA). SWA is an iterative training method that uses a convergence process. BITE’s LpModel uses Gradient Descent as its convergence process with the following cost function:

$$Cost = \frac{c}{\sum_i^M R_i} \sum_i^M \sum_j^{vector} \sum_k^{state} (A_{ijk} - P_{ijk})^2$$

M = number of matrices, R = number of rows in matrix i , A_i = answer matrix i ,
 P_i = predicted matrix i , c = hyperparameter constant

SWA is used instead of simple gradient descent to avoid falling into a local minimum and not finding a broad minimum of the cost function. When SWA is used, every round of Gradient Descent starts at a location that is a large displacement away from the previous solution in the direction opposite the gradient, and the found minima are averaged to locate the best parameters (depicted by the flags in the graph on the right). To determine how much to displace the weights during a round, a sinusoidal cyclic learning rate (α) is used that ranges from 1 (α_{max} , for large steps) to 0.001 (α_{min} , for small steps).

$$\alpha = (\alpha_{max} - \alpha_{min}) \cos\left(\frac{t\pi}{t_{max}}\right) + \alpha_{min}$$

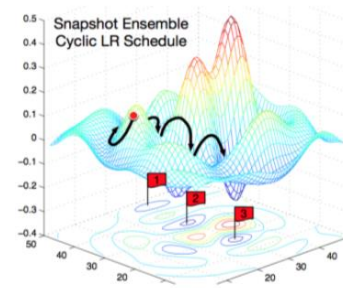

Fig. 19. SWA Process

The below table contains evaluation metrics of the trained models based on drilling test data.

Table 1. Model Evaluation Metrics

Model Name	Accuracy	Precision	Recall	LpModel Accuracy
Neural Net	0.66	0.62	0.66	≥ 0.66
Recurrent Neural Network	0.76	0.68	0.75	≥ 0.76
Hive	0.53	0.43	0.51	≥ 0.53
Gradient Boost	0.67	0.64	0.67	≥ 0.67
Logistic Regression	0.57	0.53	0.57	≥ 0.57
Hidden Markov Model	0.56	0.48	0.55	N/A

In addition to testing accuracy, precision, and recall of various models, the accuracy of the digital core was scored with the competition scoresheet for an average score of 46.9/90 when assuming a margin of error within 10% of the correct layer size.

3 Overall Competition Strategy

During set-up, PARSEC’s legs will be reattached and mounted to the testbed. Mechanical and electrical functions will be validated through a series of tests evaluating power distribution, sensor operation, and ground station communication. During the 12 hours of competition operation, PARSEC will drill and extract water from up to eight holes. The formation shown in Fig. 20 depicts the two intersecting carousel rings on which these holes will be drilled. The robot must be shifted 200 mm along the testbed after the first four holes. While melting, load cells indicate when solid ice beneath has turned to water as a gradual load reduction. The probe potentiometer will also indicate the current angle of the probe, and whether or not more slack should be given.

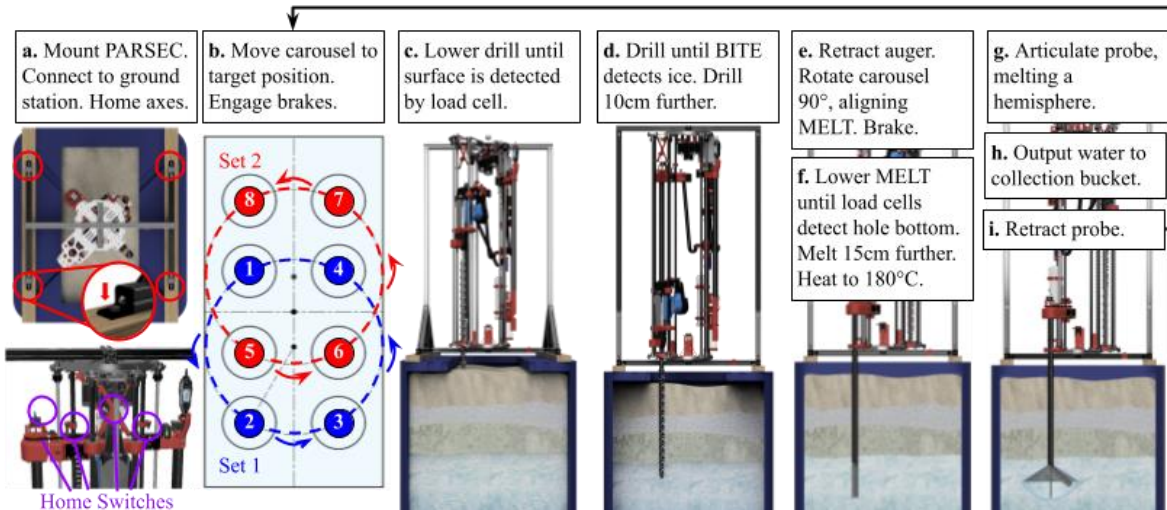

Fig. 20. Competition and Testing Procedure

4 Design Changes/Improvements

During initial drill testing, vibrations from the drill caused the auger and the rails holding the drill to oscillate. An X-shaped support with rubber dampeners was mounted to the top of the linear rails to absorb vibrations. A bearing was also added to the bottom of the carousel to prevent the auger from wobbling.

Previously a floating limit switch design was used to detect when the melting probe has reached the ice, but this would jam under any misalignment or off-axis torque. This has been replaced with a structural load cell for better reliability and continuous feedback. A dual-hyperboloid roller was also added to the bottom of the carousel to prevent MELT from wobbling.

All three tools received updating housings with built-in electronics mounting for the associated control boards, stepper drivers, and relays.

The MOLE vertical drive belt had to be spliced to the correct length and has snapped once. It has been re-spliced, but a backup chain and sprocket drive are on standby and will be implemented if issues continue. MOLE's drill also tends to heat up during long drilling periods. Because of this, a 20 minute limit on excavation operations was set.

The Filtration system has been rearranged for weight and performance improvements. A multilayer sedimentary filter is now used with a single RO membrane. A diaphragm pump is now used to achieve the pressure needed for the RO membrane, as a peristaltic pump was insufficient.

5 Technical Specifications

Table 2. Technical Specifications

System Mass	57.9 kg	Torque	14.75 N · m
System Volume	760 mm x 950 mm x 1540 mm	On-Board Computer	Jetson Nano, 5x Custom STM32 Controllers
Length of Drill Bit	860 mm	Communications Interface	Ethernet
Maximum Weight on Bit	150 N	Software	ROS, Ubuntu, Baremetal Arduino
Rated Load	9 A	Maximum Power	990 W
Heating Power	800 W	System Telemetry	All ROS topics
Drilling Speed	30.3 mm/min	MELT Rate	3.5 L/hr

6 Challenges

Reliable lab access has been an ongoing obstacle for the construction of PARSEC. The lab space underwent renovations that left it completely unavailable until mid-February. After this, the PARSEC team had extremely limited lab access for about 8 weeks. In mid-April, the lab space closed again without warning, with PARSEC locked inside. This lasted for around 6 weeks during the heart of the integration period. After this, the team was able to gain access for a few hours per week, but all of these obstacles severely decelerated the proposed timeline and limited the scope of system testing. COVID-19 limited the number of team members that could work on the system during the already limited opportunities for in-person work. It also caused supply chain disruptions that resulted in delays and shortages of some components. Nonetheless, the system has been fully constructed and tested.

7 Integration & Test Plan

PARSEC underwent three categories of tests: subsystem validation, full system integration, and data collection and reliability.

Subsystem validation took place early in the season, in tandem with design, iteration, and wiring. Novel mechanisms, such as MELT and CAT, were rapidly prototyped and validated before final versions. Other systems, such as the carousel and vertical motion, were tested once construction and wiring were completed. Subsystems and mechanisms had to withstand loads and temperatures beyond what was expected for competition. Iteration, simulation, and discussion further validated the mechanical designs. Drilling and melting tests were performed independently to validate these tools. The electrical and control systems were validated incrementally as mechanical prototypes reached completion. The control software was designed so that single device drivers (such as a stepper motor or load cell) could be verified before the system was assembled and later easily reconfigured to run the entire system. The HMM and Linear Programming Models were validated using basic unit tests, checking that values were initialized correctly and computations were correct.

Full system integration tests occurred late in the season and proved that PARSEC could seamlessly switch between subsystems and guiding iterative improvements. Full system integration tests were performed according to the competition strategy detailed in section 3. The first full system test included a successful drilling test, tool swap, and stationary melting bowl at a rate of 3.5 L/hr. It also revealed leaks in filtration plumbing.

Later full systems tests validated the filtration system and its integration with MELT. Water containing potting soil and sand with a TDS of 146 mg/L was extracted and filtered. The first stage successfully removed the larger particulate and reduced the water to a TDS of 132 mg/L. After passing the RO membrane, the water seen in Fig. 22 had a TDS of 16 mg/L.

PARSEC's test stand elevated the system using a lumber frame as shown in Fig. 21. A pair of aluminum extrusions across the center held drilling samples using a PLA clamp. The samples were prepared inside of 4" cylindrical mailing tubes, which allowed for easy swapping and greatly reduced material waste compared to an entire test stand of regolith. This efficiency was vital to the repeated testing required for digital core algorithm development. However; the walls of the mailing

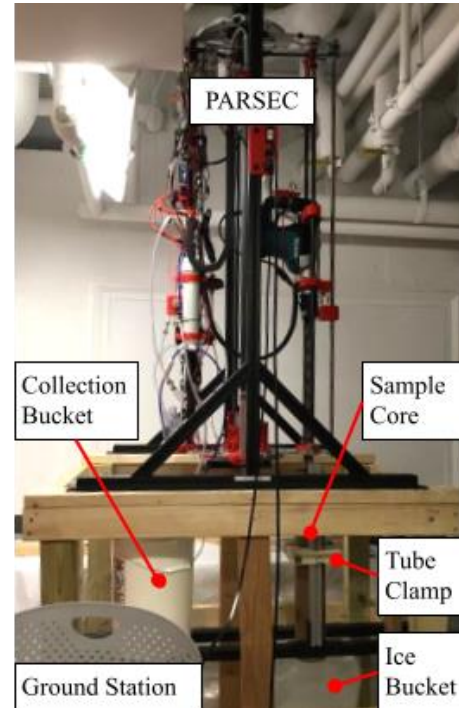

Fig. 21. Test Stand



Fig. 22. Unfiltered vs. Filtered Water

tubes corralled drilled material back into the hole, which created an accretion of material not expected during competition. This had to be manually cleared before melting which reduced the authenticity of the full system tests. Ice was held underneath the packing tubes on a step stool.

Isolated core drilling tests took place frequently to provide the digital core team with data, while also serving to stress test the system by introducing prolonged periods of vibrations.

8 Project Timeline

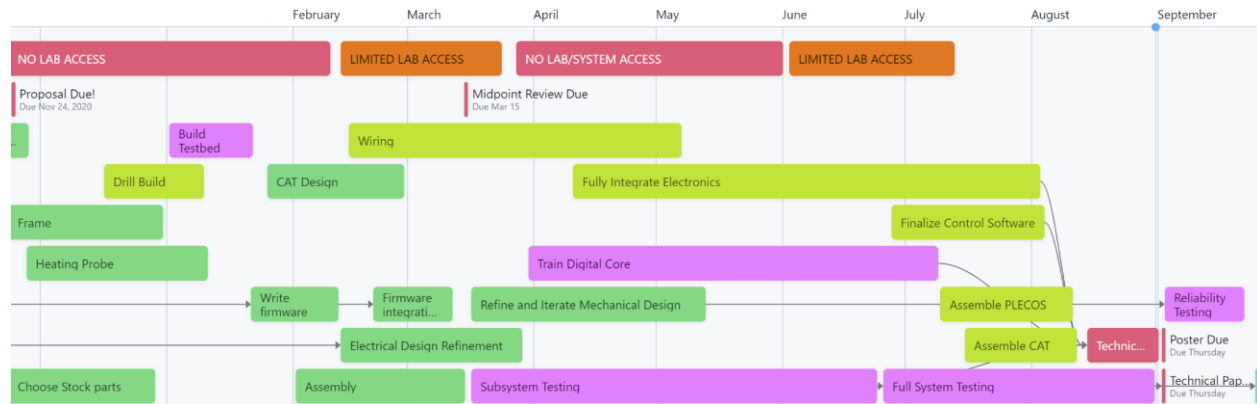

Fig. 23. PARSEC Development Timeline

9 Tactical Plan for Contingencies

Table 3. Contingency Plans for Potential Failure Modes

Failure Mode	Contingency plan
MELT articulation or rotation failure	MELT can execute the Rodwell method as a backup strategy. The compliant joint will allow the probe to be retracted, even in failure.
Failure of MOLE to excavate layers	MOLE can operate in pure percussive or pure rotary mode when needed. The auger can be removed and cleaned to refresh drilling capabilities.
Loss of axis calibration	Limit switches allow for repeated homing of all linear and rotary axes.
Clog in PLECOS	Backwash capability allows for blockages to be cleared.
Fracture of 3D printed parts	Backups will be printed for high-risk parts. A 3D printer will be brought to competition to replace parts damaged during transportation or day 1 operation.
Redundancies	Cartridge heaters, thermocouples, torsion springs, brake actuators are doubled.
Sensor Failure	Multiple digital core models were trained that may be swapped in when needed.

10 Safety Plan

Table 4. Dangers and the precautions used to mitigate them

Hazard	Safety Plan
Shock or electrocution	A GFCI and 9 A fuse was used for all mains voltage. Electrical equipment will only be operated by trained and experienced team members, and extreme caution will be used.
Drilling operations	Drill and auger are hands-off while plugged in. Ear and eye protection must be worn during excavation. Caution will be used, and abnormal tests will be terminated.

Burn risk	A thermal camera will verify that the heating probe is cooled to at least 40 °C before touching. Heat-resistant gloves will be worn if uncertain.
Pinching hazard	Members know all pinch and crush points on the system. All hands will be off the robot during operation.
System weight	The system will only be lifted by at least 4 people and will be fastened to a testbed in 4 locations before operating.
Toxic and Irritating Compounds	Toxic or irritating materials involved in PARSEC’s construction include liquid silicone, epoxy, concrete, and metal and carbon fiber shavings. Gloves were worn while working with them, and additional safety precautions from the manufacturer were followed.
COVID-19	Team members must test negative every 3 days in the absence of vaccination. All state and university guidelines will be followed. Masks must be worn during in-person meetings when closer than 6 ft.

11 Paths-to-flight

A flight-ready iteration of PARSEC must account for the challenges of space travel, extraterrestrial environments, and remote operation. Where possible, the Earth-based prototype has been designed to reduce alterations needed for the Moon and Mars.

Prior to landing, PARSEC must be equipped with protection from airborne debris, which have an average diameter of 3.4 μm [1]. Similar to past NASA rovers on Mars, PARSEC could implement a protective lander structure with three ‘petals’ [2]. The petals will enclose the system while landing and then unfold following touch down. The petals of the lander will have Vectran cloth attached to their skeleton. Vectran has a tensile strength of 26 g/denier and an operating range of -34 °C to 220 °C [3][4]. It is therefore capable of performing under Martian temperatures and rough terrain. An additional rug of Vectran cloth will be placed underneath the system to ensure a stable surface for mounting and limit abrasion. The lander will deploy a parachute and fire a sequence of thrusters that will decelerate PARSEC similarly to the Mars Curiosity rover [5]. The Vectran cloth petals and rug will be left behind following the system’s landing.

The first configuration of the space-ready PARSEC system would require manual transportation to drilling sites. PARSEC’s carousel contains all systems necessary to harvest potable water within a compact 0.7 m diameter cylinder. For the on-Earth system, PARSEC has mounting legs that extend beyond the profile of the carousel. The legs will fold upwards and be kept flush to the frame via a wire rope which is released upon landing. Previously implemented on NASA’s Perseverance rover, quick release bolts will be used to drop the restrained legs back into place, slimming the overall build [6]. This allows PARSEC to travel into space fully assembled while matching the cylindrical profile of most rocket fairings.

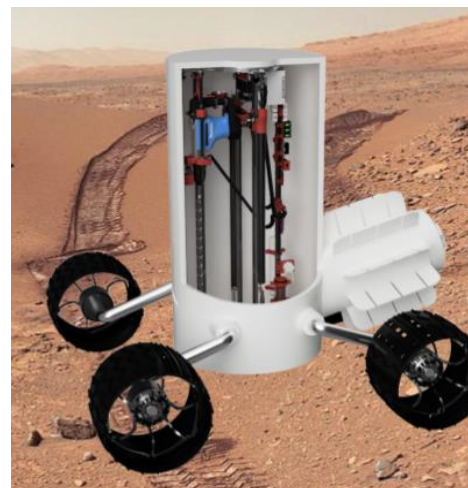

Fig. 24. Mobile PARSEC Modifications

PARSEC could alternatively achieve mobility by mounting to a rover chassis as seen in Fig. 24. The rover will be equipped with stereographic navigation cameras to create 3D imagery of the rover’s surroundings. These would work in tandem with onboard software to avoid obstacles and autonomously

traverse the terrain [7]. PARSEC’s travel will be planned and communicated to the rover via a triage of antennae previously used on NASA’s Perseverance rover: ultra-high frequency, X-band high-gain, and X-band low-gain [8].

The BITE and CHEW algorithms add to PARSEC’s ability to function autonomously in space. BITE’s data gives real-time predictions, which can be used to autonomously switch system operations from drilling to melting after ice has been reached. Solely using current terrestrial data would cause supervised learning techniques to be poor predictors on the Martian or lunar surfaces. To mitigate this issue, new drilling tests in an environment better representing the real Martian and lunar surface characteristics would be performed. For materials that are too different from any previously known, CHEW would automatically switch to unsupervised learning to cluster the data to just provide visualizations of the novel material instead, providing a label to it when informed by CAT or Earth.

CAT has the capability to collect regolith samples for research, testing, and validation purposes. With an additional sample testing module, perchlorate levels on Mars could be tested and taken into account when drilling for water collection. Since perchlorate levels in Mars soil can range anywhere from 0.5-1.0% concentration, the CAT system could designate areas with low levels as safe for water collection and reduce the potential chemical hazard to astronauts [9]. CAT could be used to validate predictions from both BITE and CHEW by collecting samples at suspected layer changes and areas of uncertainty flagged by BITE. Validation of predictions would allow for online or continuous learning while on Mars, as they could inform parameter tuning of models based on the new knowledge. The addition of a hyperspectral camera to CAT could allow for enhanced material identification and classification.

Before PARSEC can operate on the Moon or Mars, there are several general space-ready system improvements that require attention. The following table explores these topics and their solutions.

Table 5. Spaceflight Concerns and their Respective Solutions

	Concerns	Solution
Mechanical	Fasteners will become loose from vibrations during launch and landing.	Fasteners will be secured using anaerobic adhesive: Loctite 222, per NASA fastener requirements.[10]
	Most metal parts on PARSEC are aluminum, which is too soft to withstand deformities.	Replace aluminum parts with a titanium alloy, and reduce their size/thickness [11].
	3D printed parts were made using the fused deposition modeling method with PLA filament. These layers could delaminate.	These parts would be remanufactured in a traditional machining method with isotropic properties and optimized materials.
	The weight of the system is excessive for space travel.	A system redesign would be done to reduce the part count, complexity, and total weight.
Electrical	The current system is designed to use AC power from a wall outlet that would not be present on the Moon or Mars.	PARSEC would implement a radioisotope thermoelectric generator (RTG) and store this energy in a set of batteries for up to 14 years. This RTG would also emit heat, making it double as a heating system for the electronics [12].

	PARSEC does not have a way to communicate back to Earth from space.	An antenna would be added to PARSEC connecting it to the NASA Deep Space Network[13].
	PARSEC's control boards are custom made, however, the other boards are not. These take up more space and are heavier.	The remaining stock hardware would be consolidated to reduce the footprint of electronics and weight.
	To control the system, it must be connected to a laptop that has software installed on it.	All groundstation processing will be moved to PARSEC's onboard computer.
	There is only one of each part of the electronic system. If one fails, the entire system could.	Redundant electronics would be installed with duplicates of crucial components like ICs and sensors. In the event of component failure, software could switch to using the backup.
	Limited data storage onboard Jetson nano and possibility of data corruption or memory degradation	Separate non-volatile memory will be used for storage of data. Important data will either be backed up on redundant storages or transmitted to Earth.
Environmental	On the Moon and Mars, the temperatures vary from -173 to 127 °C and -125 to 20 °C, respectively [14]. Electronics do not function well under extreme temperatures.	Solid silica aerogel, a highly effective insulating and lightweight material, would surround the electronics and gold paint would be sprayed on the outside of PARSEC to reduce energy from radiating from the system [15].
	PARSEC will be exposed to space radiation that would cause power resets and system failures in the electronics [16]. For polymers there would be an increase in elongation, reduction of hardness, and decrease in elasticity [17].	Any electronics would be radiation hardened and any metal or plastic would be put in a radiation hardened container. Lead metal alloys are optimal for radiation shielding [18]. Thin sheeting of these materials can be implemented throughout the system for further protection.
	Exposure to dust could be detrimental to the mechanical function of the system.	Carousel turntables already have minimal exposed surface area, but further shielding would be added. Ball screws and linear rails would be shielded with flexible bellows. Vectran cloth can likewise be added as a shielding.

11.1 Mars Operation

When preparing for prospecting and extracting operations on Mars, it is imperative to consider where PARSEC will land. The drilling and melting tools are currently designed to reach 1m depth of overburden and ice, per competition testbed dimensions. However, NASA orbiters have detected Mars underground ice deposits that reach upwards of 100 meters subsurface. The following image visualizes ice deposit depth for locations across Mars [19]

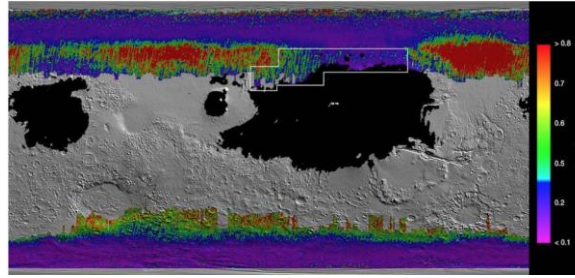

Fig. 25. NASA orbiter data on Mars Ice deposit depths subsurface

PARSEC will work with pre-launch software intelligence to land in the Arcadia Planitia region located in the white box of Fig. 25. As seen above, this region in particular has shallow water ice depths. It is therefore a prime location to begin drilling operations as the ice is at a depth within PARSEC's reach.

Once the location is settled, there are further concerns present during the water extraction phase. The approximate pressure on Mars is 0.095 psi compared to 14.5 psi on Earth [20]. Due to this significant drop in pressure, ice can immediately sublime if exposed to the Martian atmosphere, as seen in Fig. 26. This graph illustrates that liquid water cannot exist on Mars without additional pressure as its atmospheric pressure dips just below the triple point.

In preparation for the Martian environment, MELT and PLECOS are designed with spaceflight in mind. The stage 1 filter of PLECOS utilizes a peristaltic pump, capable of self-priming and operating in a vacuum. The diaphragm pump on PLECOS would need to be replaced with a peristaltic pump to account for the low Martian atmospheric pressure. One advantage to using an RO-based filtration system is that it can remove the majority of perchlorates from water. Alternatively,

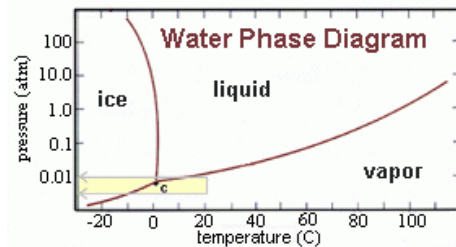

Fig. 26. Water Triple Point

for purer water, distillation could replace the current filtration system. In this case, water is collected as a vapor and separated from solid contaminants. This would require minimal energy as the Martian atmosphere supplies the conditions necessary for water vaporization. If this route were taken, melted ice would be pumped into a collection chamber, vaporized, and then pumped through a heat exchanger where it is condensed and collected for use. Additionally, PARSEC will need to implement an onboard water storage container that would deliver water to larger accumulation tanks.

Depending on the current distance between the Earth and Mars, the approximate communication lag is five to twenty minutes and substantial autonomy of the system is therefore required [8]. With lag as a consideration, it is crucial to develop a finite state machine to sequentially control PARSEC's operations. This will prevent operator error and allow for autonomous failsafes such as over current or automatic tool retraction and swapping. To ensure system reliability during autonomous operation, additions would be needed to PARSEC's codebase to catch unforeseen faults and implement a harsher set of simulated scenarios. Each microcontroller would also need to be outfitted with a real-time operating system to allow for dynamic error detection and process prioritization. With the power of the current onboard GPU, PARSEC is able to quickly process information such as the current level of overburden it is in contact with while drilling.

11.2 Lunar Operation

On the Moon, PARSEC would only perform prospecting, allowing the system to be greatly streamlined to reduce cost, volume, and weight. Melting and filtering systems will be removed. The gravity on the Moon is only one-sixth of that on Earth, so PARSEC is vulnerable to dislodging while drilling on the Moon’s surface. Therefore, the drill will operate in pure rotary mode unless its sensors deem percussion necessary. A method to tether the system to the Moon’s surface, such as the microgravity anchoring system developed by JPL, would be implemented if necessary. [12].

PARSEC also could travel to the Moon fully assembled on an integrated rover drive base or individually, with the need to be manually transported to drilling sites. Because the lag time from Earth to the Moon is only approximately one second [21], the rover could be driven remotely from Earth.

12 Budget

In addition to the \$10,000 development stipend provided to all finalists and \$2,980 remaining from our 2020 season, the team received several products and services for free or reduced cost. Igus provided free linear rails and linear bearings. Dalton Electric provided a generous discount on customized profiled cartridge heaters with nested thermocouples. Conmet Milling & Turning provided invaluable access to CNC machines and expertise. Nvidia provided 3 Jetson Nano microcontrollers. The team’s sponsors were vital for the ambitious project that PARSEC became, and we thank them all for their contributions.

Table 6. Sources of Funding

Source	Item	Value
RASC-AL	2020 Stipend Remainder	\$2,980
NVIDIA	3x Jetson Nano’s	\$300
RASC-AL	2021 Stipend 1	\$5,000
Igus	Linear rails & bearings	\$711.60
Dalton Electric	Heater Discount	\$360.78
Conmet Milling & Turning	Machining Access	
RASC-AL	2021 Stipend 2	\$5,000
Total Funds		\$12,980
Received-in-kind		\$1,372

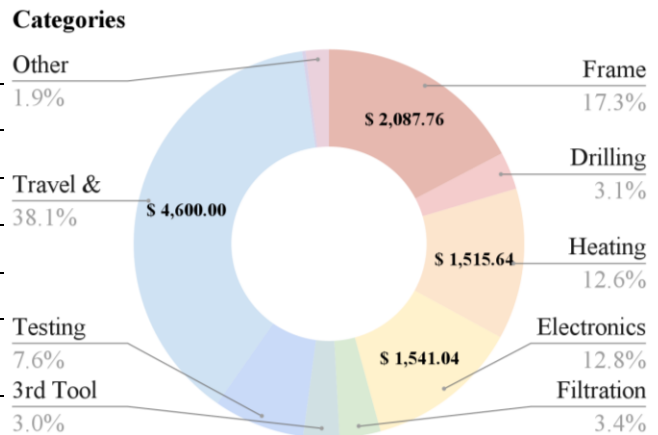

Fig. 27. Budget Distribution



Fig. 28. The sponsors that made PARSEC possible

References

- [1] *Safe on Mars: Precursor Measurements Necessary to Support Human Operations on the Martian Surface*. Washington, D.C.: National Academies Press, 2002, pp. 15-26.
- [2] "The Lander Structure", *Mars Exploration Rovers*. NASA. [Online]. Available: <https://mars.nasa.gov/mer/mission/spacecraft/entry-descent-and-landing-configuration/lander-structure/>. [Accessed: 30- Aug- 2021].
- [3] "Vectran™", *Kuraray America*. [Online]. Available: <https://kuraray.us.com/products/fibers/vectran/>. [Accessed: 31- Aug- 2021].
- [4] "Vectran® In fibres, yarns and fabrics for technical textiles", *IMATTEC*. [Online]. Available: <https://imattec.com/en/vectran.php>. [Accessed: 31- Aug- 2021].
- [5] "Mars Curiosity Rover - Entry, Descent, and Landing", *NASA's Mars Exploration Program*. NASA. [Online]. Available: <https://mars.nasa.gov/msl/timeline/edl/>. [Accessed: 31- Aug- 2021].
- [6] R. Bradley, "Grabbing hold and letting go: The exploding bolts that bring us to space", *Popular Science*, 2019. [Online]. Available: <https://www.popsoci.com/exploding-bolts-travel-through-space/>. [Accessed: 31- Aug- 2021].
- [7] "The Rover's "Eyes" and Other "Senses"", *Mars Exploration Rovers*, 2021. NASA. [Online]. Available: <https://mars.nasa.gov/mer/mission/rover/eyes-and-senses/>. [Accessed: 31- Aug- 2021].
- [8] "Communications", *NASA's Mars 2020 Mission Perseverance Rover*. NASA. [Online]. Available: <https://mars.nasa.gov/mars2020/spacecraft/rover/communications/>. [Accessed: 31- Aug- 2021].
- [9] A. F. Davila, D. Willson, J. D. Coates, and C. P. McKay, "Perchlorate on Mars: a chemical hazard and a resource for humans," *International Journal of Astrobiology*, vol. 12, no. 4, pp. 321–325, 2013.
- [10] National Aeronautics and Space Administration (2018). Requirements For Threaded Fastening Systems In Spaceflight Hardware. Office of the NASA Chief Engineer.
- [11] "Aluminium Alloys vs Titanium Alloys - Comparison - Pros and Cons |Material Properties", *Material Properties*. [Online]. Available: <https://material-properties.org/aluminium-alloys-vs-titanium-alloys-comparison-pros-and-cons/>. [Accessed: 31- Aug- 2021].
- [12] "Electrical Power", *NASA's Mars 2020 Mission Perseverance Rover*. NASA. [Online]. Available: <https://mars.nasa.gov/mars2020/spacecraft/rover/electrical-power/#:~:text=The%20power%20source%20is%20called,the%20rover%27s%20two%20primary%20batteries.> [Accessed: 31- Aug- 2021].
- [13] "Communications with Earth", *NASA's Mars Exploration Program*. [Online]. Available: <https://mars.nasa.gov/msl/mission/communications/>. [Accessed: 31- Aug- 2021].
- [14] "Planetary surface temperatures - Earthguide Online Classroom", *Earthguide.ucsd.edu*, 2017. Earthguide & Scripps Institution of Oceanography [Online]. Available: http://earthguide.ucsd.edu/eoc/special_topics/teach/sp_climate_change/p_planet_temp.html. [Accessed: 31- Aug- 2021].
- [15] "Rover Temperature Controls", *Mars Exploration Rovers*, 2021. NASA. [Online]. Available: <https://mars.nasa.gov/mer/mission/rover/eyes-and-senses/>. [Accessed: 31- Aug- 2021].
- [16] R. Ladbury, Radiation Hardening at the System Level. NASA Goddard Space Flight Center, 2007.
- [17] Nuclear and Space Radiation Effects on Materials. NASA, 2015.
- [18] "What Makes Lead Good for Radiation Shielding?," Canada Metal North America. [Online]. Available: <https://www.canadametal.com/lead-good-for-radiation-shielding/>
- [19] A. Good and A. Johnson, "NASA's Treasure Map for Water Ice on Mars", NASA, 2019. [Online]. Available: <https://www.nasa.gov/feature/jpl/nasas-treasure-map-for-water-ice-on-mars>. [Accessed: 31- Aug- 2021].
- [20] Mars Education. n.d. Developing the Next Generation of Explorers. Arizona State University [online] Available at: <<https://marsed.asu.edu/mep/atmosphere/>> [Accessed 31 August 2021].
- [21] Space Academy. n.d. *Communication Delay*. Australian Space Academy [online] Available at: <<https://www.spaceacademy.net.au/spacelink/commdly.htm>> [Accessed 31 August 2021].